

PRZEKRÓJ A-A



Tolerancja wymiarowa $\pm 0,5$ mm

Elementy składowe:
 - korpus
 - pokrywa
 - 2x wkręt

Format A4	Skala 1:1
Nr produktu KM-86	



MASZCZYK[®]

OBUDOWY DLA ELEKTRONIKI

„MASZCZYK”
 05-071 Sulejówek-Miłosna
 ul. Mickiewicza 10

tel: (22) 783-45-20 kom: 602-726-086

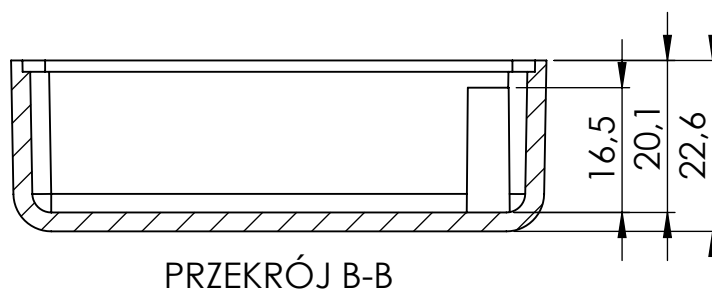
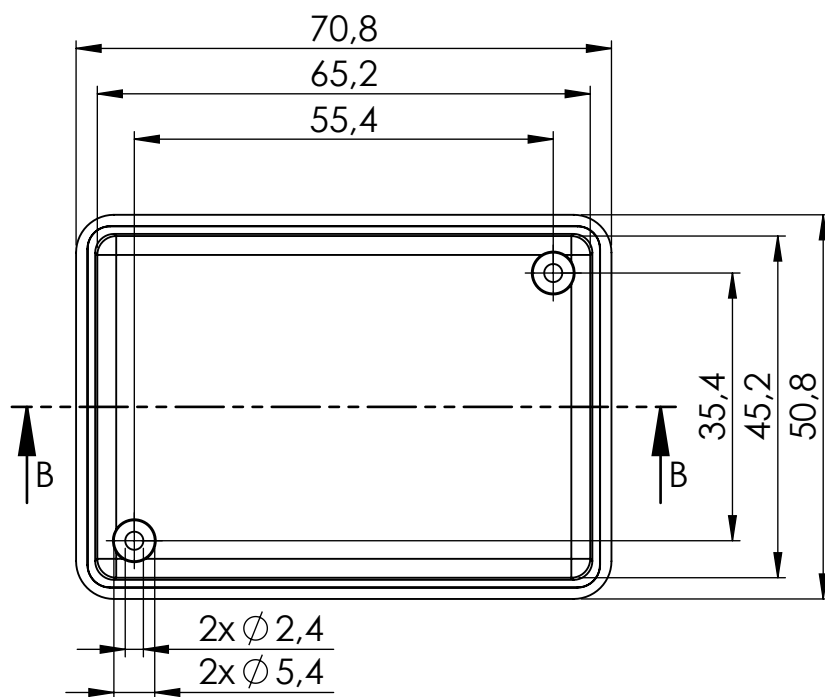

Tolerancja wymiarowa $\pm 0,5$ mm

Format A4	Skala 1:1
Nr produktu KM-86 (korpus)	



MASZCZYK[®]

OBUDOWY DLA ELEKTRONIKI

„MASZCZYK”

05-071 Sulejówek-Miłosna

ul. Mickiewicza 10

tel: (22) 783-45-20 kom: 602-726-086

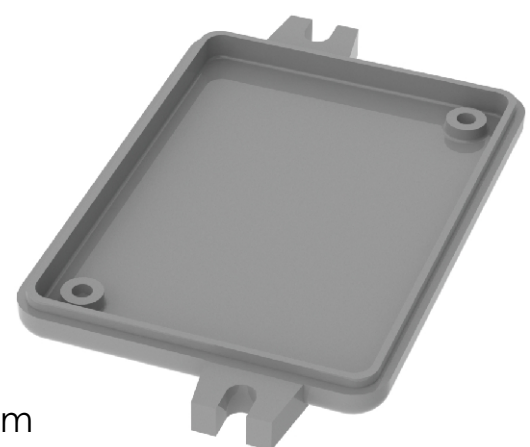
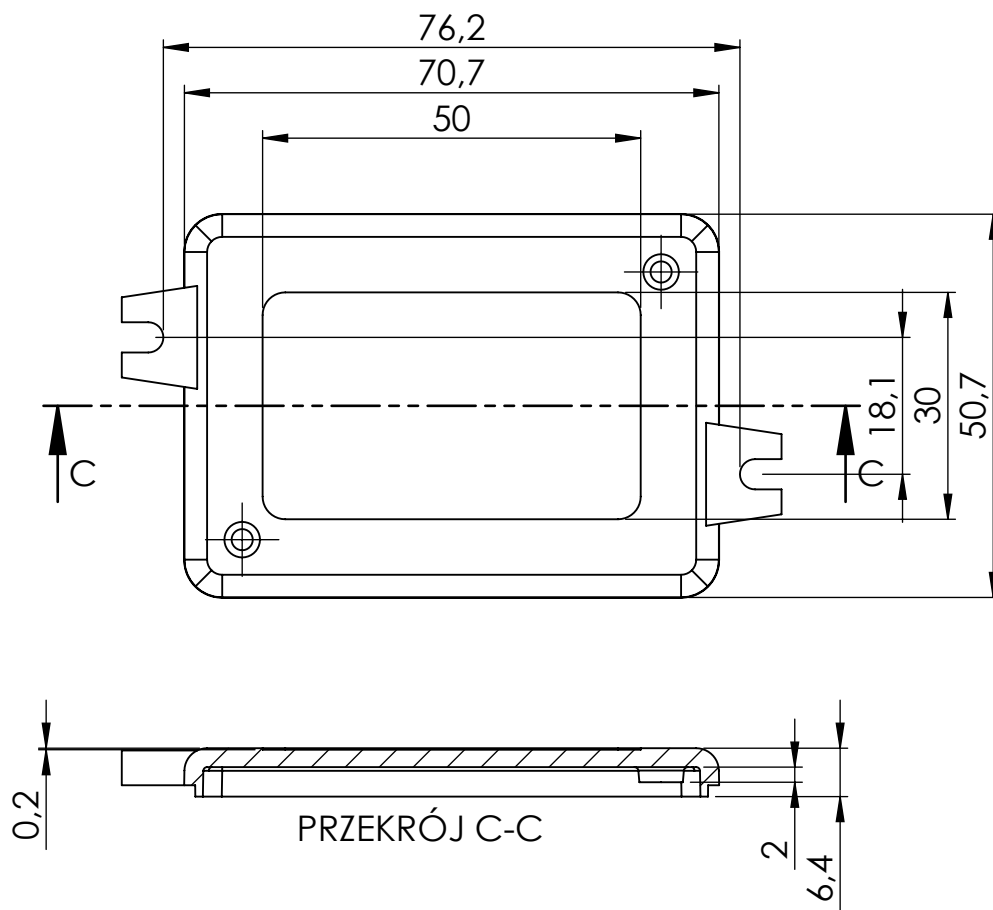

Tolerancja wymiarowa $\pm 0,5$ mm

Format A4	Skala 1:1
Nr produktu KM-86 (pokrywa)	



MASZCZYK[®]

OBUDOWY DLA ELEKTRONIKI

„MASZCZYK”
05-071 Sulejówek-Miłosna
ul. Mickiewicza 10

tel: (22) 783-45-20 kom: 602-726-086